

·MAŁY·KONSTRUKTOR·
·CONSTRUCTOR·
JUNIOR

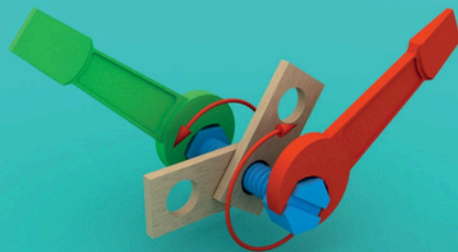

SPOSÓB UŻYCIA NARZĘDZI

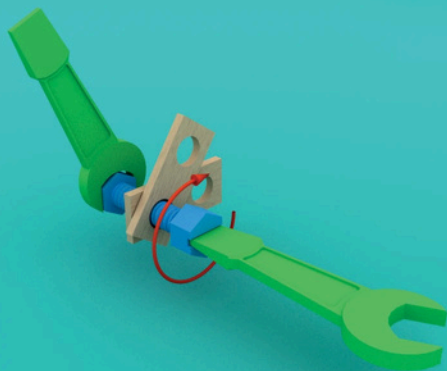



klucz x 2



D03 x 9



D04 x 2



D05 x 4



D07 x 2



DL02 x 4



WD12H160 X 2



D02 x 3



13mm
SP001 x 5



13mm
SP001 x 3



13mm
SP001 x 9



24mm
SP004 x 6



0705 X 4



0716 X 4



NP001 x 31



KP001 x 14



33mm
SP002 x 2

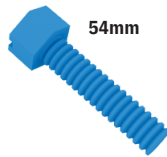

54mm
SP003 x 3

 x 2

 x 2

 x 2

KP001

SP001

KP001

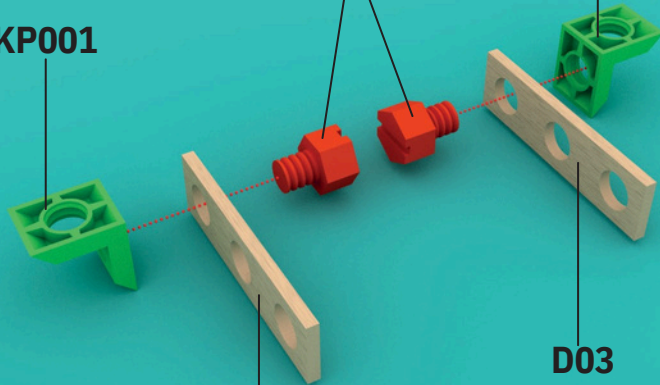

1

SP001

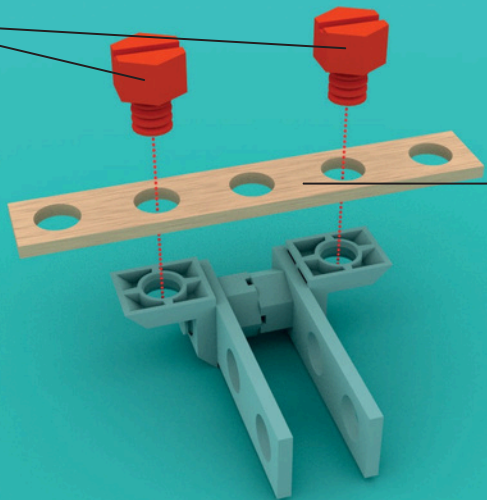

 x 1

 x 2

D05



x 2



x 2

x 2

SP001

KP001

DL02



DL02

KP001

3

NP001

KP001

-  x 1
-  x 1
-  x 2

SPO 03

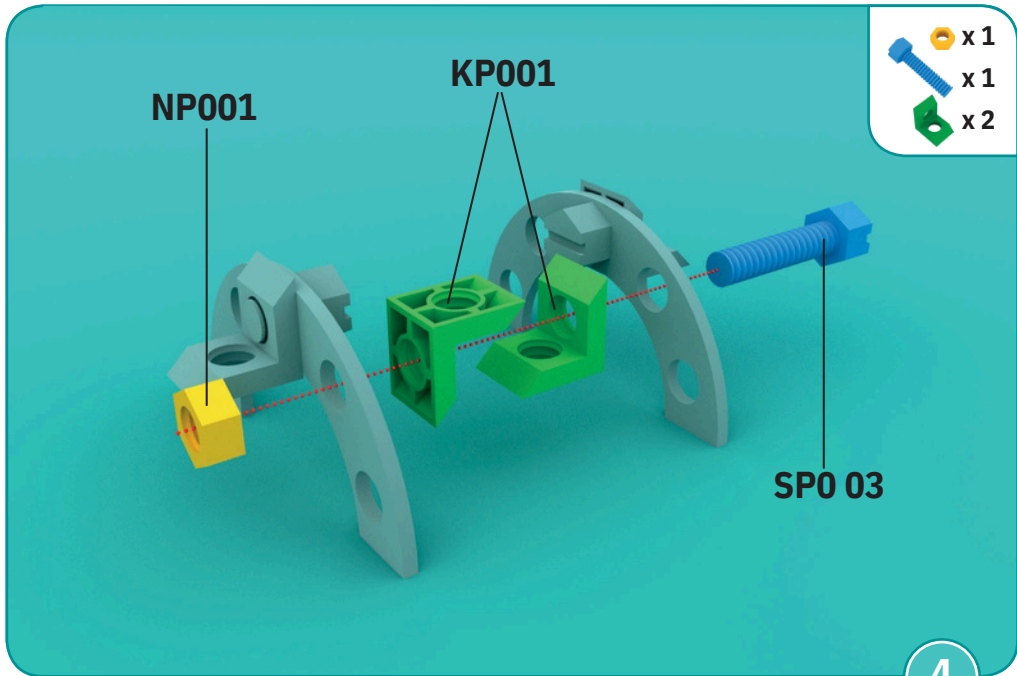

 x1

 x1



D02



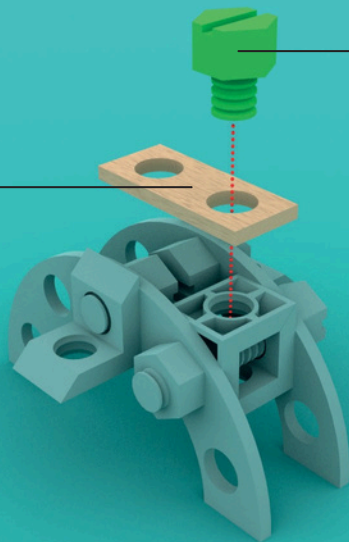

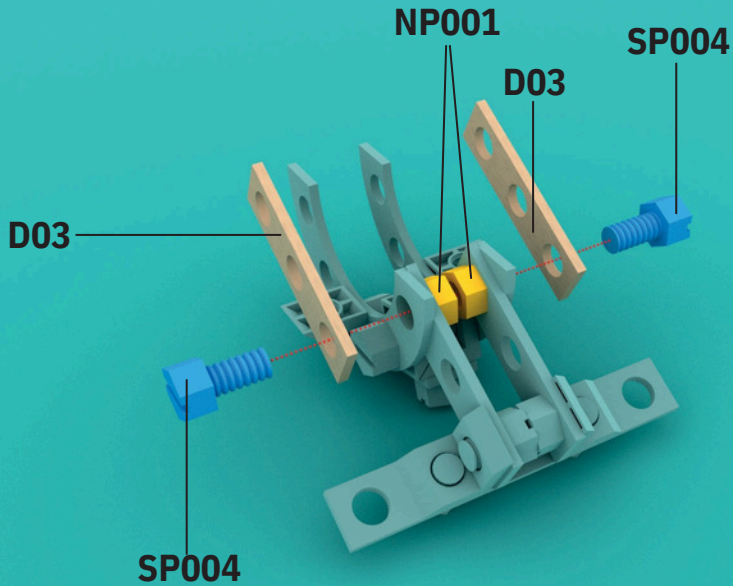
SP001

5





-  x 2
-  x 2
-  x 2

-  x 2
-  x 2
-  x 2
-  x 2

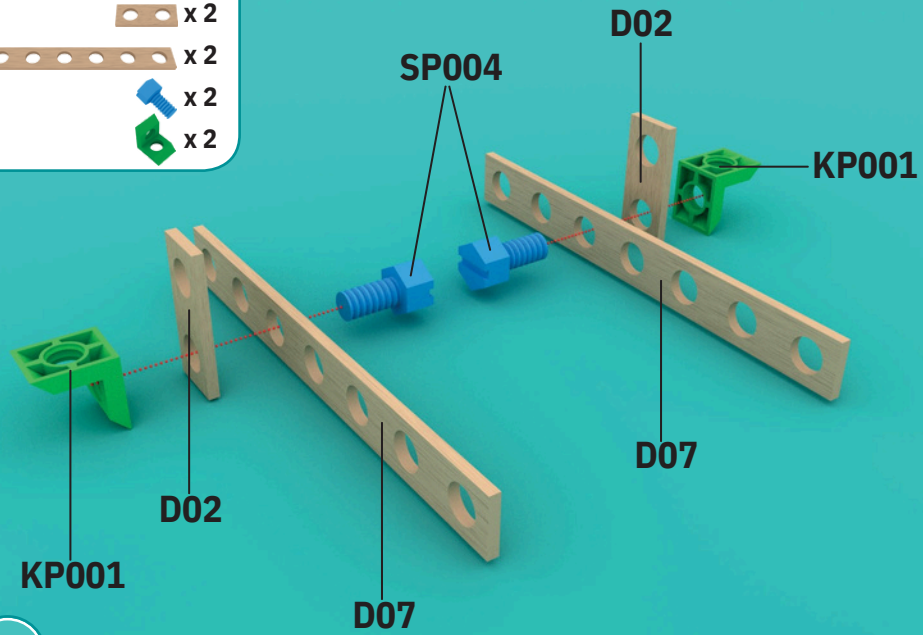

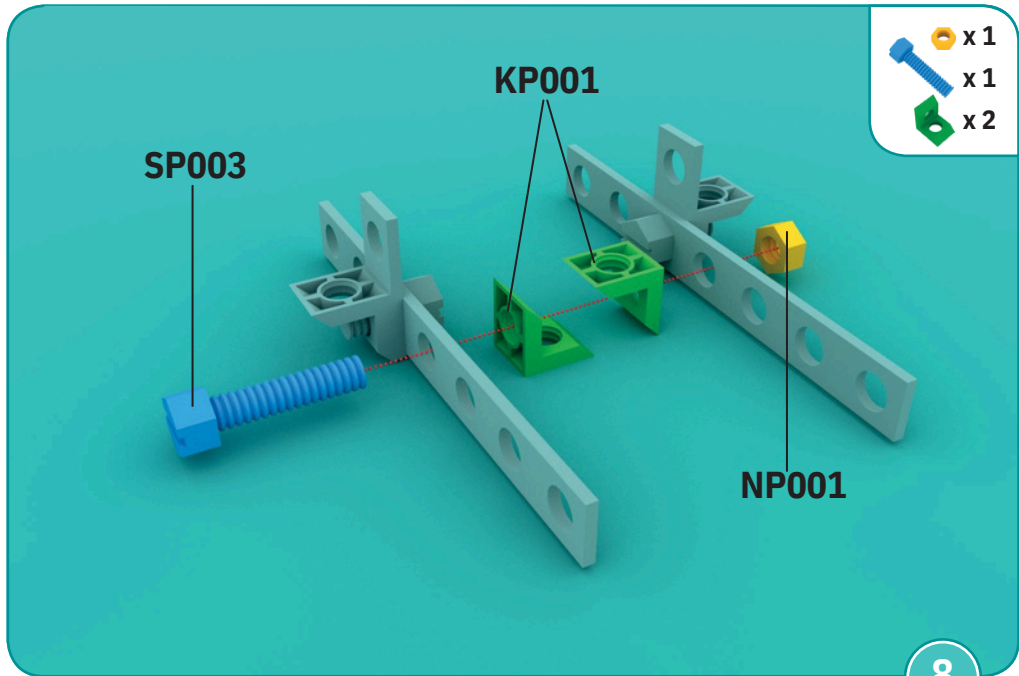

 x 1

 x 1

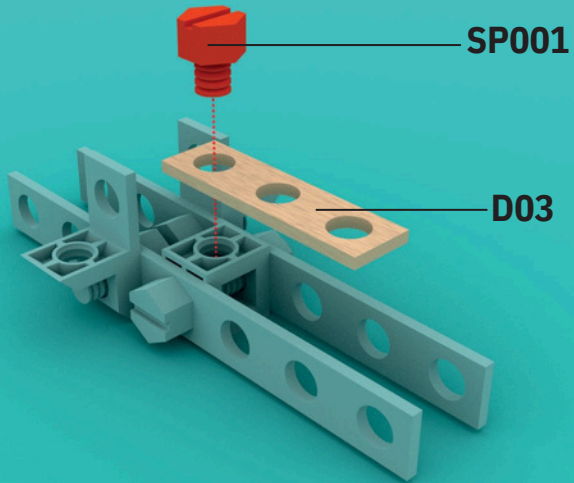

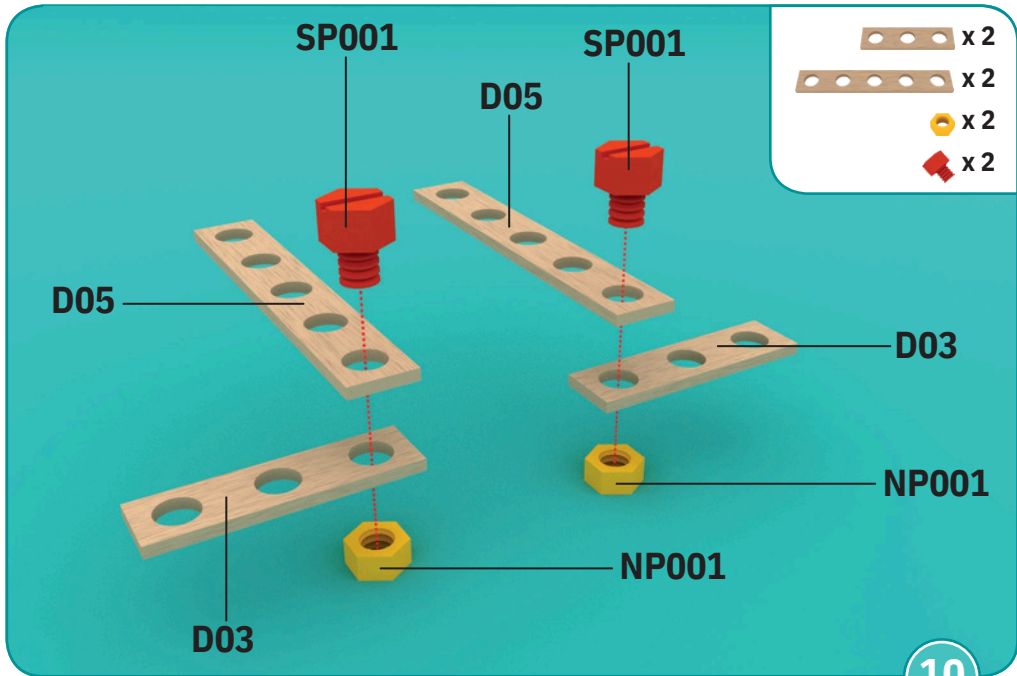

 x 2

 x 2

SP004

NP001

SP004

11

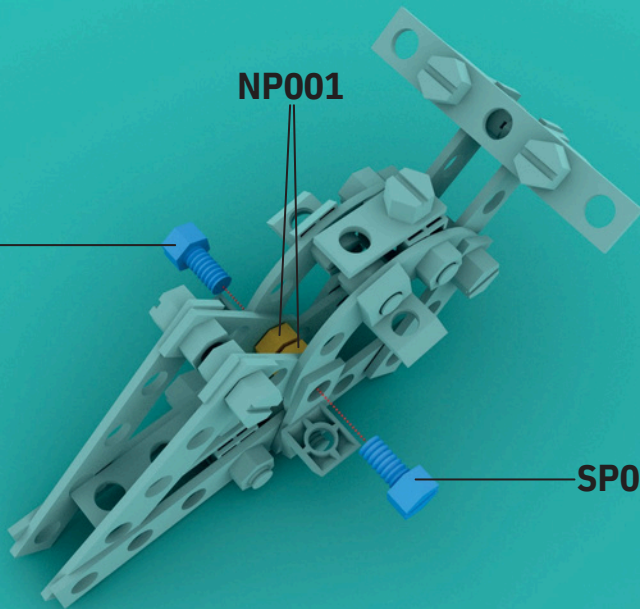

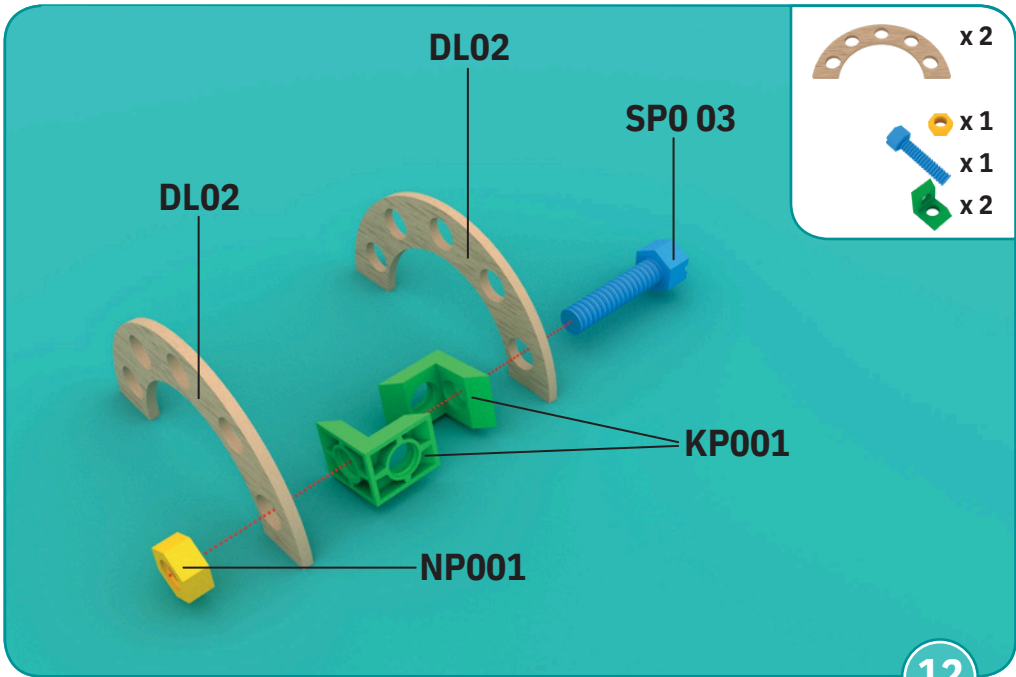

 x 1

 x 1

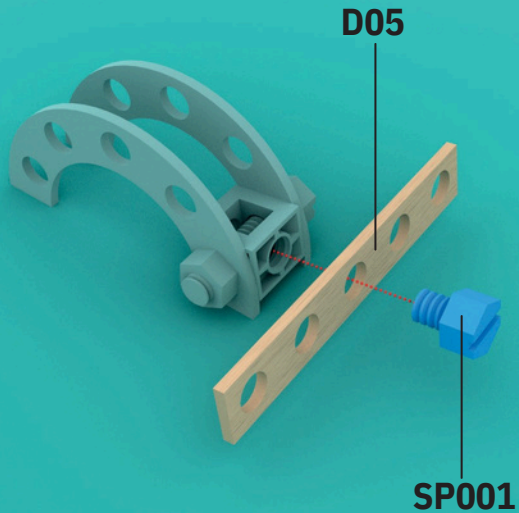

 x 2

 x 2

SP001

NP001

SP001

x 2

x 2
x 2

KP001

SP001

SP001

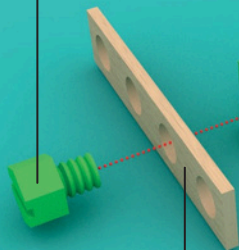

D04

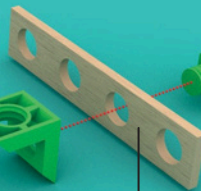
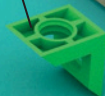
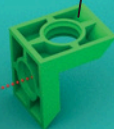

D04



